



ALL-IN-ONE SMALL POND FILTER SYSTEM **CUP-311**



2500 LITRES PER HOUR PUMP

11W UV CLARIFICATION

COMPLETELY SUBMERSIBLE

FOR PONDS UP TO 4000 LITRES

INCLUDES COARSE FILTER FOAM
& BIO FILTER MEDIA

To ensure your new pond filter system is set up and running correctly, and to prevent any accidental damage or injury, please read and follow the below instructions carefully before using your product.

SAFETY

IMPORTANT! Disconnect the mains electricity supply before attempting any installation / maintenance of any kind. Do not attempt to modify this unit in any way and only use the recommended parts for replacement.

- The all-in-one CUP system should never be run dry as this will cause the unit to overheat and cause permanent damage.
- All connections must be earthed.
- The power cord of this appliance cannot be replaced; if the cord is damaged, the appliance should be discarded. Never cut the cord.
- Do not connect to any voltage other than that stated.
- Do not place in liquids other than water.
- Do not use with water above 90°F or 30°C.
- Do not carry or pull the unit by its electrical cable.
- Do not use this unit if it has a damaged cord, if it is malfunctioning or it is dropped or damaged in any manner
- Do not attempt to modify this unit in any way and only use attachments and the recommended parts for replacement recommended by the manufacturer.
- Before installing, maintaining or handling your equipment, or before placing your hands in your pond, ensure that the unit is disconnected from the electricity supply.
- Always disconnect any electrical devices when not in use.
- Carefully examine your pond system after installation. Do not connect the unit to the mains if there is water on any parts not intended to be wet.
- Do not look directly at the UV light when it is operational.
- Before operating your CUP system observe that water is flowing through it - the UV requires constant flow to avoid overheating.

- To avoid injury, do not touch hot or moving parts such as, but not limited to UV bulbs or impellers.
- During maintenance ensure all O-rings are present and intact.
- If the appliance shows any signs of water leakage or the RCD unit switches off, disconnect the unit from the power supply and consult the retailer where you purchased the unit.
- Do not install or store this unit where it will be exposed to temperatures near to 0°C / 32°F. In freezing conditions, remove and store the unit in a sheltered area ensuring all water has been drained from the filter.
- Do not bury the cord for this unit. Ensure it does not cause a trip hazard or it at risk from damage from lawn mowers, strimmers or other garden equipment.
- This is a submersible product - do not operate the product if not fully submerged.

Please note – this appliance can be used by children aged from 8 years and above and persons with reduced physical, sensory or mental capabilities or lack of experience and knowledge, provided they are given supervision and instruction concerning use of the appliance and understand the hazards involved. Children must not play with the appliance. Any maintenance must not be made by children without supervision.

ELECTRIC

This unit comes complete with a generous supply of 3 core cable, however should any additional cable be required, the use of an approved waterproof cable connector with a proper rating is essential. A cord rated for less amperes or watts than the appliance rating may overheat.

Please Ensure:

- The power supply must be earthed and fused at 3amps.
- You regularly inspect the cable for damage and deterioration.
- Do not connect to any voltage other than that stated.
- You consult a qualified electrician if in doubt about any aspects of wiring.
- A residential current device (RCD) is used for additional safety
- You have complied with Local Electricity Authority regulations if permanently installing to the mains supply.

Please Ensure: The power supply must be earthed and fused at 3amps. Regularly inspect the cable for damage and deterioration. Consult a qualified electrician if in doubt about any aspects of wiring.

CHOOSING YOUR FILTER LOCATION

- The pressure of your unit depends on many factors such as pond depth, stock density and hose dimensions. To enhance pond water quality, we recommend considering these factors to ensure maximum efficiency and avoid low return pressure.
- Place your unit on a level and sturdy surface at the bottom of your pond with outlet facing upwards.

INSTALLATION & USE

Please read the below instructions carefully before beginning to set up your filter system. **DO NOT CONNECT THE UNIT TO THE MAINS UNTIL SET UP IS COMPLETE AND UNIT IS FILLED WITH WATER.**

1. Prior to installing the unit, examine the quartz sleeve and UV bulb to make sure these have not been damaged in transportation (see maintenance section). Handle with care. Do not hold UV bulb with bare hands as this can affect performance.
2. Clean filter media and foam - remove the filter media plate and clean through the included media and coarse foam with some pond water.

3. Connect the required attachments - Choose the required attachments.



Fountain attachment set included compromises of:

- Main fountain extendable pole (essential for using the fountain feature)
- Optional water diverter for use of additional features
- Optional hosetail nozzle to fit 12mm, 20mm and 25mm hose (for use with water diverter or on its own without fountain feature)
- 3 fountain outlet attachment for varying effects
- On stepped hosetails if using a hose larger than the smallest dimension, you will need to cut down the hosetails to avoid restricting the flow of water.

3. Position the filter system unit - fully submerge your CUP unit. Place it on a level and sturdy surface at the bottom of your pond with outlet facing upwards.

4. If using a hosetail nozzle - connect your flexible hose to the hosetail. Safely connect using either jubilee / wire clips to ensure this is water tight. It is always best to position your unit at the opposite end to where the water returns to the pond to provide maximum circulation.

5. Connect your all-in-one system to the mains - Connect the unit to the mains using a residual current device (RCD) for additional safety.

6. Switch on your unit at the mains - turn on the operation by switching on the unit at the mains.

UVC OPERATION

- Always ensure that the filter has water flowing through the unit prior to operating the UV.
- Never look directly at the UV light when operational.
- Check that the UV is operational visually using the UV indicator.
- Never operate the UV lamp outside its housing.
- Never operate the UV lamp in a housing that's defective.

MAINTENANCE

To ensure optimal performance and that your unit functions correctly, regular maintenance is essential. Failure to do so may result in damage to your unit and may invalidate your warranty.

We recommend that a regular cleaning and maintenance schedule is followed to ensure responsible fishkeeping. Depending on water volume and stocking levels, regular cleaning of the filter media, foams, impeller, inlet/outlet pipework will help ensure that the product works efficiently and your pond remains healthy.

For further maintenance guidance, please see the table and additional information below:

	1 MONTH	3 MONTHS	6 MONTHS	ANNUALLY
All Pipework	Clean & Inspect			
Hosing				Clean & Inspect
O-Rings	Clean & Inspect	Lubricate & Clean		Replace
Filter Foams	Clean & Inspect			Replace as required (1-2 years)
UV Bulb				Replace
Quartz Sleeve			Clean & Inspect	Replace after 2 years
Other Media (K1 & Ceramic Filter Media)	Clean & Inspect			

O-rings

It is vital that O-rings are regularly inspected and replaced as the rubber watertight seal will perish over time, which may cause your unit to leak. Before replacing your o-rings, ensure they are well lubricated to ensure the seal is kept water tight.

Filter Maintenance

In general, it is recommended to disconnect your filter and clean the pipes, impeller and filter media monthly. Pipework will become blocked with waste and protein slime over time, so regular cleaning is important for optimal performance.

The frequency of how often you will need to clean and inspect your unit of course will depend on a lot of factors like how dirty the water is when you first start using your all-in-one system, your pond volume and also how many fish you have. How often you feed your fish and seasonal light levels will also affect how quickly your pond water gets dirty and will need to be taken into consideration when planning how often to clean your filter system.

Filter Media

The filter media provided with your unit and their positioning within the filter body are designed to give complete and optimum filtration for your pond.

Coarse Filter Foam	Mechanical Filtration	Removes small waste particles from the water.
Ceramic Stones & K1 Filter Media	Biological Filtration	Create environment for nitro-bacteria to cultivate and help oxygenate the water.

IMPORTANT! Always use water from your pond to clean your filter sponges and media. Do not use mains water or any cleaning products to clean your media.

When replacing media in your filter, do not replace more than 50% of your media at once. This is to ensure that the nitrifying bacteria present in the old media are able to repopulate in the newly added filter media.

General Maintenance

It is recommended that every 3-4 weeks you perform maintenance on the CUP-311.

Filter casing - can be removed by unfastening the casing clips on the side of the filter body and removing the filter casing. Please note you need to remove any attached outlets before opening the casing.



Remove and clean filter sponge and filter media - remove the filter media plate and clean through the included media and coarse foam.

Rinse them in pond water to prevent damaging the beneficial bacteria which help maintain a healthy pond.

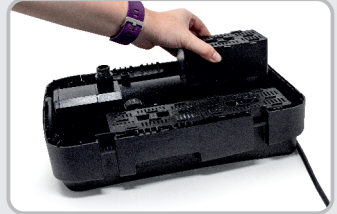

Impeller - can be accessed by removing the pump's front casing. Simply rotate it in anti clockwise direction.

The impeller can then be gently pulled away from the housing and inspected.

Ensure that the plastic propeller part of the impeller is attached to the magnetic part and that they have not come apart or split. If this is the case you need to replace your impeller.

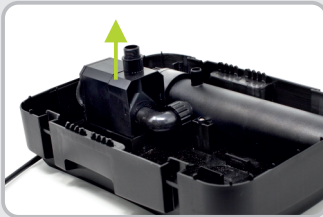

Quartz sleeve & UV bulb - remove the UV clarifier from the unit by unscrewing two screws (as shown in the image below). To access UV bulb unfasten the clip located on the side. Gently rotate the housing to remove it.

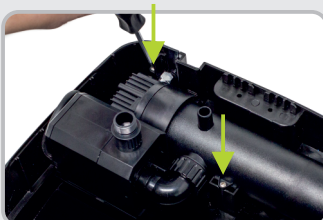

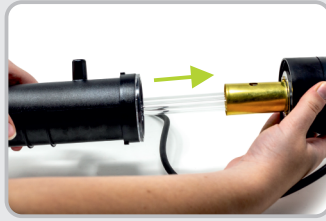

To access quartz sleeve loosen it up by inserting a flathead screwdriver between the quartz sleeve and quartz sleeve housing (see reference image below). Gently pull it out to remove it.



The quartz sleeve can be coated in limescale build up in hard water areas. This should be carefully removed from the quartz sleeve and cleaned with a soft cloth.

Clean body and all attachments. Reassemble.

Adding All Pond Solutions Filter Start Bacteria Treatment after filter maintenance will help replenish beneficial populations of bacteria and is highly recommended during the first two months of operation when the filter is slowly being colonised.

Replacing the UV Bulb

NEVER look directly at the UV light.

When replacing your UV bulb, use this time to clean your quartz sleeve and carefully examine for any damage or cracks. Take care when handling the quartz sleeve and UV bulb to avoid any damage to the glass.

1. Unfasten the clip located on the side of the UV clarifier.
2. Gently rotate housing to remove it. Once cooled, UV bulb can be safely removed by gently moving it from side to side and pulling free of unit.

IMPORTANT! The replacement does not require removal of the gold outer shell protecting the bulb. The top of the gold outer shell has sharp edge, DO NOT touch this part.

3. You can now replace your UV bulb and reassemble the unit.

IMPORTANT! Check regularly that your UV light is operational by looking at the UV light indicator located on the top of the filter casing. Always change your UV bulb every twelve months regardless of it working or not, as its performance will lessen by this stage. We recommend to replace your bulb every 6 months if used for aquarium and 12 months if used for pond.

The CUP-311 uses a 11w two pin PLS UV bulb.



PARTS DIAGRAM

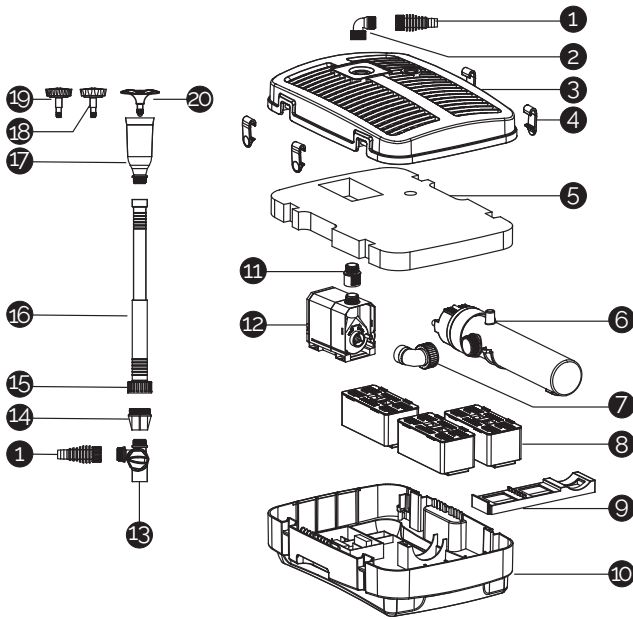

1 HOSETAIL OUTLET

2 HOSETAIL ELBOW

3 FILTER CASING

4 CASING CLIP

5 COARSE FOAM

6 UV CLARIFIER

7 PUMP > UV ELBOW

8 FILTER BASKETS

9 FILTER PLATE

10 FILTER BODY

11 PUMP ADAPTOR

12 PUMP

13 T OUTLET

14 FOUNTAIN ADAPTOR

15 FOUNTAIN NUT

16 FOUNTAIN PIPE

17 FOUNTAIN HEAD CONNECTOR

18 FOUNTAIN HEAD 1

19 FOUNTAIN HEAD 2

20 FOUNTAIN HEAD 3

PARTS DIAGRAM

UV Clarifier

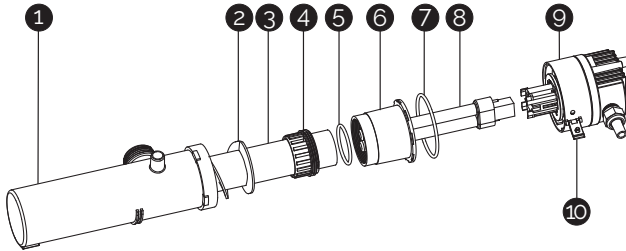

1 UV BODY

2 UV HELIX

3 UV QUARTZ

4 UV QUARTZ NUT

5 QUARTZ O-RING 1

6 QUARTZ CONNECTOR

7 QUARTZ O-RING 2

8 UV BULB

9 UV BALLAST

10 BALLAST LATCH

Water Pump

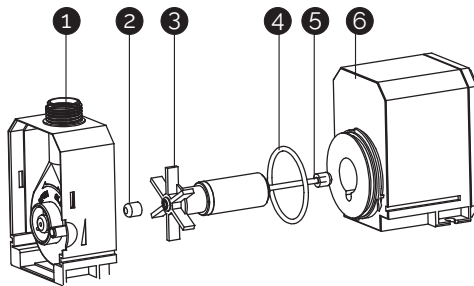

1 PUMPCASING

2 IMPELLER RUBBER

3 IMPELLER

4 IMPELLER O-RING

5 SHAFT

6 PUMP MOTOR

TROUBLESHOOTING

UV Indicator is not Lighting Up

If the UV indicator on the top of the filter casing is not lighting up follow these troubleshooting steps:

1. Clean the UV indicator.
2. If you find that the UV light is still not operational, check that you have power from the mains supply.
3. If you do have power from the mains supply, check if you can see the UV is operational through the viewing hole on top of the UV clarifier. If you aren't able to see it, try performing a safety override. Locate the safety override switch on the ballast end next to the UV bulb fitting (as shown in the image on the right).



IMPORTANT! NEVER look directly at the UV light.

Press and hold the small thin silver switch when the power is on and the bulb should ignite. Please test in a dark/ shadowed place and do not look directly at the bulb – we recommend covering the bulb with kitchen roll or similar. You should still be able to see the glow of the bulb through this.

4. If the above does not solve the issue replace the UV bulb.
5. Please check for signs of damage or water ingress to quartz sleeve and bulb area. You might need to replace your quartz sleeve and/or O-Ring if that's the case.
6. If you find that the UV light is still not operational after the bulb replacement, the UV ballast may have developed a fault and you will need to contact the supplier of your unit to obtain replacement parts.

Please remember that UV bulbs for use in ponds should be replaced every 12 months.

Slow Flow Rate

1. Rinse unit's coarse foam making sure it's free of debris. For optimum function of the unit, we highly recommend the filter is positioned on a brick, so it is not resting directly on the bottom on the pond. This is to prevent large clumps of debris blocking the inlets and restricting the flow.
2. Locate the impeller and shaft in the pump and inspect for damage and clear the fittings and parts of any waste build-up.
3. Ensure that the plastic propeller part of the impeller is attached to the magnetic part and that they have not come apart or split. If these parts looks fine and there are two rubber grommets fitted on each end of the shaft, or already inside the fittings, then re-assemble the unit.

Green Water or Cloudy/Brown Water?

In order to correctly identify if you have green water or cloudy/brown water, a settlement test should be carried out.

Take a jar of pond water and allow to settle for 24 hours.

Green Tinge - If your jar is showing mostly green tinged water or has green particles floating in it, you most likely have a bit of an algae problem (follow the green water trouble shooting guide).

Brown Tinge / Water with Sediments - this indicates that you have organic debris decomposing in your pond. This can be particles from dead leaves, twigs and other plant debris that are breaking down (follow the brown water trouble shooting guide).

The UV Bulb is on But My Pond is Green

There are a lot of different factors which contribute to this type of issue and it may not be the UV system at fault. The steriliser will work to maintain rather than transform water quality so you may need to add treatments to clear poor quality water or consider a heavy water change.

Algae growth in water can be due to high phosphate and nitrate and green water is heightened in the summer period due to the extra sunlight so it is also advised that a water test is carried out.

If the UV light is working then the product is functioning correctly. The position of the pond should also be considered, as this affects how much sunlight is directly falling on the pond. Algae growth is very likely to require a treatment to resolve the growth. Consider purchasing the All Pond Solutions Green Water treatment or Blanketweed treatment.

The orientation of the garden can also be an issue; south facing gardens inevitably get more sunlight and can cause ponds to be greener in the summer if exposed all day. Try and shade your pond water surface, plants are a great way to do this.

My Pond Water is Cloudy/Brown

1. Make sure the unit is turned on 24 hours a day. Continuous running is needed to maintain a clean and healthy pond.
2. Remove pond waste and leaves and carry out a partial water change. If sludge is present treat your pond with All Pond Solutions Anti Sludge treatment.

3. Reduce feeding. Overfeeding introduces a lot of organic waste and is one of the main causes for cloudy water problems.
4. Make sure to perform regular water changes, check your unit is clean and adequate for your pond size and do not overstock it.

My Unit is Cutting Out

1. Rinse unit's coarse foam making sure it's free of debris. For optimum function of the unit, we highly recommend the filter is positioned on a brick, so it is not resting directly on the bottom on the pond. This is to prevent large clumps of debris blocking the inlets and restricting the flow.
2. Inspect the quartz sleeve for hair line cracks and ensure that all O-rings are in place and well lubricated.
3. Locate the impeller and shaft in the pump and inspect for damage and clear the fittings and parts of any waste build-up.
4. Ensure that the plastic propeller part of the impeller is attached to the magnetic part and that they have not come apart or split. If these parts looks fine and there are two rubber grommets fitted on each end of the shaft, or already inside the fittings, then re-assemble the unit.

Poor Fountain Performance

1. **Reduced height** - extend the fountain attachment.
2. **Lime scale / waste build up** - clean flow adjusters and fountain head.
3. **Waste blockage** - remember to keep your unit raised slightly above the floor level in your pond to help reduce the waste pulling through the filter.

If none of the above resolves your issue, or you require spare parts for your filter, please contact the supplier of your unit.

SPECIFICATIONS

MODEL:	CUP-311
UV POWER (WATTAGE):	11W
FLOW RATE:	4000 L/H
DIMENSIONS (LxWxH) (mm):	387 x 275 x 136
HEIGHT MAX:	2.5m
MAX DEPTH OF USE:	2m
CABLE LENGTH:	10m (Plug not included)
VOLTAGE:	220-240v / 50Hz
POWER:	57W

WARRANTY

The All Pond Solutions CUP All-In-One System range is guaranteed against defects in material or workmanship under normal pond usage and comes with 24 months warranty for all electrical parts. The warranty period commences from the date of purchase.

If you require support on how to use your unit, replacement parts or if your filter develops a fault during the warranty period, please contact the supplier of your unit.

Non-replaceable, non-perishable and non-serviceable parts will be repaired or replaced free of charge, once the unit is returned with all components along with a valid proof of purchase and postage paid. We reserve the right to replace or repair the unit at our discretion.

Please be aware that perishable parts that are subject to normal wear and tear, such as impellers, impeller covers, motor seals and UV bulbs, are not covered by your warranty and a charge may be required for replacements of these.

This warranty does not apply to any unit that has been subjected to misuse, accidental damage, negligence, tampering or customisation. It does not apply to units which have been assembled incorrectly, improperly maintained, or where the instructions and safety information in this manual has not been followed correctly.

No liability is assumed with respect to loss or damage to livestock or personal property irrespective of the cause thereof.

Please ensure that only genuine All Pond Solutions components are used when completing a replacement or repair. Spare parts are available at our official website or from your local supplier.

Before returning your unit under warranty terms, check that all setup and maintenance instructions have been correctly followed. If you are in doubt, please contact your local aquatic retailer for further advice before returning the product.

This does not affect your statutory rights.



www.allpondsolutions.co.uk

All Pet Solutions Limited Trading as All Pond Solutions
Unit 203 Riverside Way, Uxbridge, Middlesex,
England, UB8 2YF